

**MICRO CONTROLLER X
COMMUNICATION
FUNCTIONS
(RS-485 MODBUS)**

TYPE: PXR

NOTICE

1. Exemption items from responsibility

The contents of this document may be changed in the future without prior notice.

We paid the utmost care for the accuracy of the contents. However, we are not liable for direct and indirect damages resulting from incorrect descriptions, omission of information, and use of information in this document.

CONTENTS

1. COMMUNICATION FUNCTIONS	1
1.1 General	1
2. SPECIFICATIONS	2
2.1 Communication Specifications	2
3. CONNECTION	3
3.1 Terminal Allocation	3
3.2 Wiring	4
4. SETTING OF COMMUNICATION CONDITION	5
4.1 Set Items	5
4.2 Setting Operation Method	6
5. MODBUS COMMUNICATION PROTOCOL	7
5.1 General	7
5.2 Composition of Message	8
5.3 Response of Slave Station	10
5.4 Function Code	11
5.5 Calculation of Error Check Code (CRC-16)	12
5.6 Transmission Control Procedure	13
5.7 FIX Processing (Cautions at write-in of data)	15
6. DETAILS OF MESSAGE	16
6.1 Read-out of Bit Data [Function code:01 _H]	16
6.2 Read-out of Read-out Only Bit Data [Function code:02 _H]	17
6.3 Read-out of Word Data [Function code:03 _H]	19
6.4 Read-out of Read-out Only Word Data [Function code:04 _H]	22
6.5 Write-in of Bit Data (1 bit) [Function code:05 _H]	24
6.6 Write-in of Word Data (1 word) [Function code:06 _H]	25
6.7 Write-in of Continuous Word Data [Function code:10 _H]	26
7. ADDRESS MAP AND DATA FORMAT	28
7.1 Data Format	28
7.2 Address Map of Internal Calculation Value Data	31
7.3 Address Map of Engineering Unit Data	36
7.4 Additional Explanation of Address Map	41
8. SAMPLE PROGRAM	44
9. TROUBLESHOOTING	49

1. COMMUNICATION FUNCTIONS

1.1 General

- PXR provides a communication function by RS-485 interface, by which it can transmit and receive data to and from host computer, programmable controller, graphic display panel, etc.
- The communication system consists of master station and slave stations. Up to 31 slave stations (PXR) can be connected per master station.
Note that, because the master station can communicate with only one slave station at a time, a party to communicate with must be specified by the "Station No." set at each slave station.
- In order that the master station and slave station can communicate, the format of the transmit/receive data must coincide. For the PXR, the format of the communication data is determined by the MODBUS protocol.
- Please use an RS-232C↔RS-485 converter in case of designating a personal computer or other devices which have an RS-232C interface as a master station.

[RS-232C↔RS-485 converter] (recommended article)

Type: KS-485 (non-isolated type)/SYSTEM SACOM Corp.

Type: SI-30A (isolated type)/SEKISUI ELECTRONICS Co., Ltd.

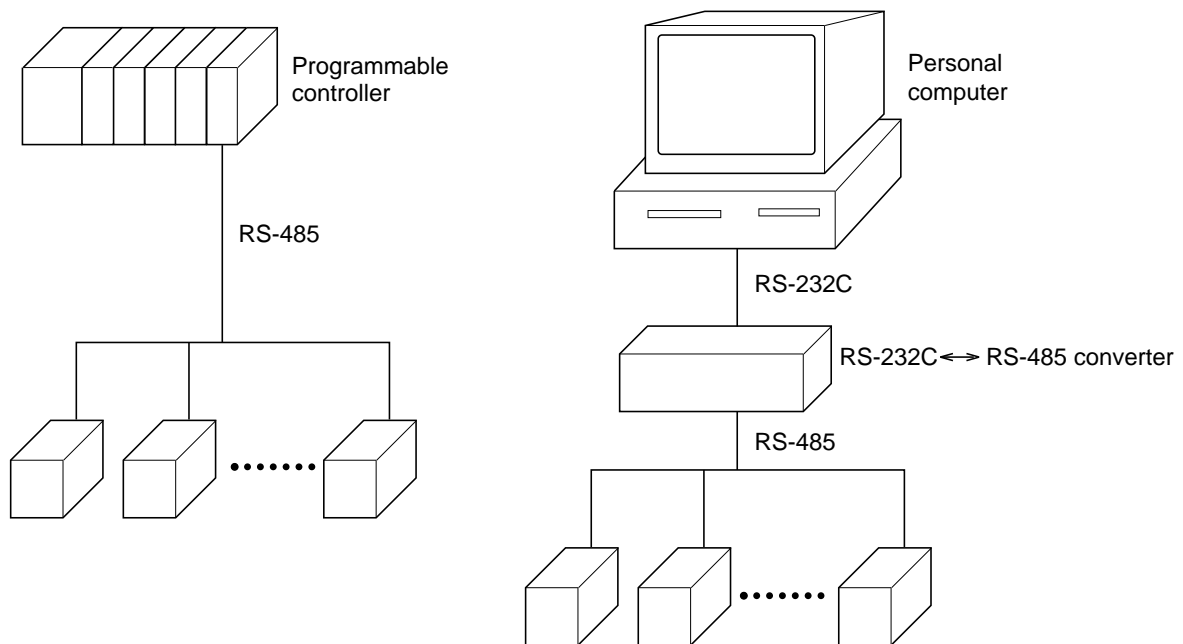

[Note] MODBUS[®] is the registered trade mark of Gould Modicon.

2. SPECIFICATIONS

2.1 Communication Specifications

Item	Specification	
Electrical specification	Based on EIA RS-485	
Transmission system	2-wire, semi-duplicate	
Synchronizing system	Start-stop synchronous system	
Connection format	1 : N	
Number connectable units	Up to 31 units	
Transmission distance	500m max. (total extension distance)	
Transmission speed	9600bps	
Data format	Data length	8 bits
	Stop bit	1 bit
	Parity	none, even, odd (selectable)
Transmission code	HEX value (MODBUS RTU mode)	
Error detection	CRC-16	
Isolation	Functional isolation between transmission circuit and others (withstand voltage : 500V AC)	

3. CONNECTION



WARNING

For avoiding electric shock and malfunctions, do not turn on the power supply until all wiring have been completed.

3.1 Terminal Allocation

Terminal number	Signal name
7	+
8	-

3.2 Wiring

- Use twisted pair cables with shield.
Recommended cable: UL2464, UL2448, etc.
- The total extension length of the cable is up to 500 m. A master station and up to 31 units of the PXR can be connected per line.
- Both ends of the cable should be terminate with terminating resistors 100 Ω 1/2W.
- The shield wire of the cable should be grounded at one place on the master station unit side.
- If the PXR is to be installed where the level of noise applied to the PXR may exceed 1000 V, it is recommended to install a noise filter in the master station side as below.
Recommended noise filter: ZRAC2203-11/TDK

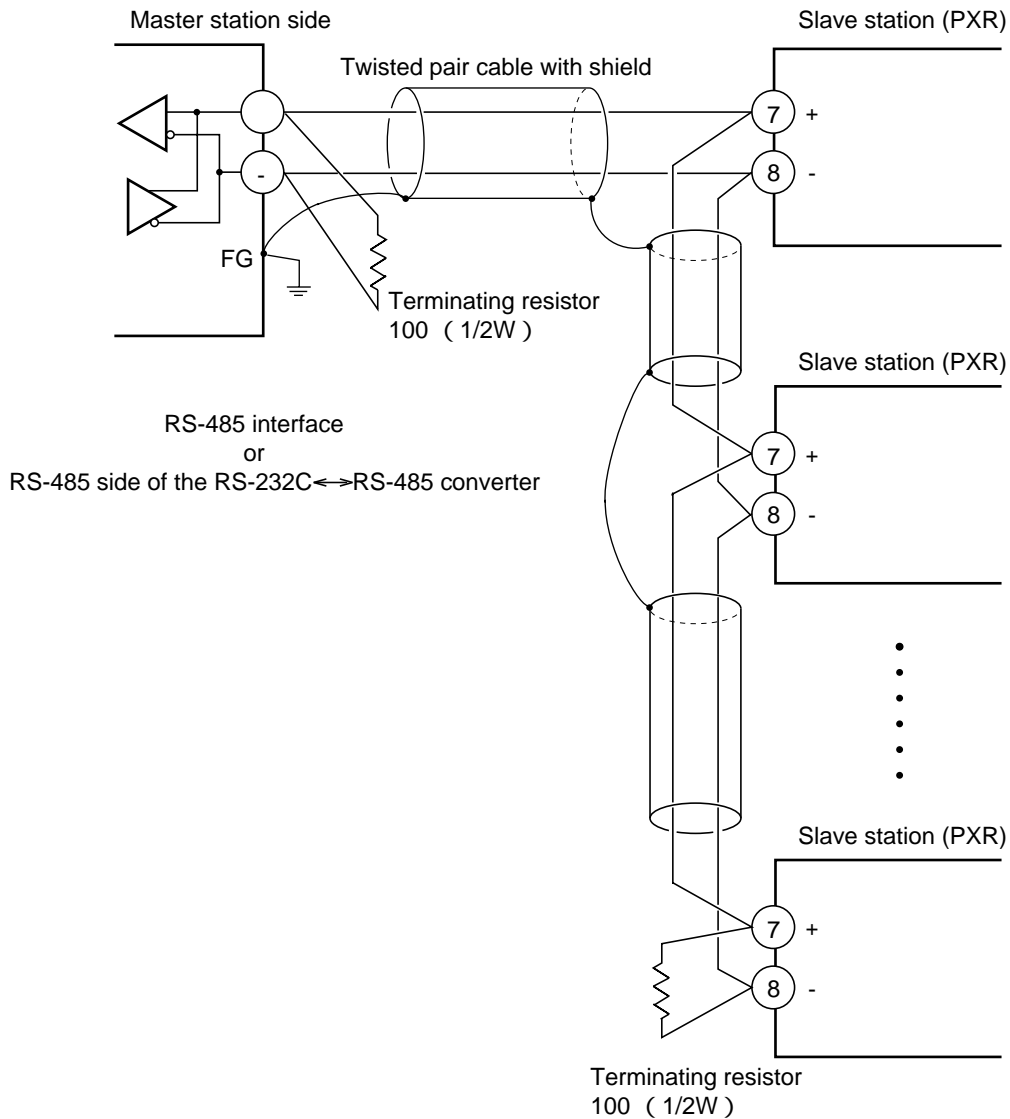
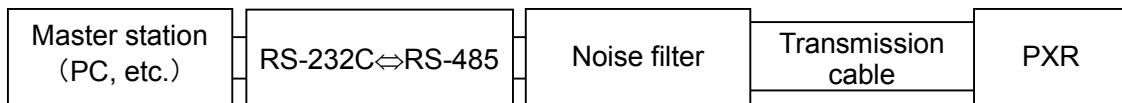

4. SETTING OF COMMUNICATION CONDITION

In order that the master station and instrument (PXR) can correctly communicate, following settings are required.

- All communication condition settings of the master station are the same as those of instruments (PXR).
- All instruments (PXR) connected on a line are set to "Station Nos. (STno)" which are different from each other. (Any "Station No." is not shared by more than one instrument.)

4.1 Set Items

The parameters to be set are shown in the following table. Set them by operating the front panel keys.

Parameter symbol	Item	Value at delivery	Setting range	Remarks
———	Transmission speed	9600bps	Fixed (can not be changed)	Set the same communication condition to the master station and all slave stations.
———	Data length	8 bits	Fixed (can not be changed)	
———	Stop bit	1 bit	Fixed (can not be changed)	
CoM	Parity setting	0	0: odd parity 1: even parity 2: none parity	
STno	Station No.	1	0 to 255 (0:communication function stop)	Set a different value to each station.

4.2 Setting Operation Method

The following example shows how to set the communication conditions.

Example: Selecting an even parity and “STno=18” on a station.

Key operation	Indication	Description		
	<table border="1"> <tr><td>200</td></tr> <tr><td>200</td></tr> </table>	200	200	Running state (PV/SV indication)
200				
200				
SEL (6 seconds)	<table border="1"> <tr><td>P-n1</td></tr> <tr><td>0</td></tr> </table>	P-n1	0	Press the SEL key for approximately 6 seconds. P-n1 appears and No. 3 block parameter is selected.
P-n1				
0				
∨	<table border="1"> <tr><td>STno</td></tr> <tr><td>0</td></tr> </table>	STno	0	Operate the ∨ key repeatedly until STno parameter appears. (If past over, operate the ∧ key to return.)
STno				
0				
SEL	<table border="1"> <tr><td>STno</td></tr> <tr><td>0</td></tr> </table>	STno	0	Press the SEL key. The numeric value on the lower indicator blinks and the setting mode is selected.
STno				
0				
∧∨	<table border="1"> <tr><td>STno</td></tr> <tr><td>18</td></tr> </table>	STno	18	Operate the ∧ or ∨ key to change the numeric value to 18.
STno				
18				
SEL	<table border="1"> <tr><td>STno</td></tr> <tr><td>18</td></tr> </table>	STno	18	Press the SEL key again. The numeric value stops blinking and the setting is registered.
STno				
18				
∨	<table border="1"> <tr><td>CoM</td></tr> <tr><td>0</td></tr> </table>	CoM	0	Press the ∨ key to display the CoM parameter.
CoM				
0				
SEL	<table border="1"> <tr><td>CoM</td></tr> <tr><td>0</td></tr> </table>	CoM	0	Press the SEL key. The numeric value on the lower indicator blinks and the setting mode is selected.
CoM				
0				
∧∨	<table border="1"> <tr><td>CoM</td></tr> <tr><td>1</td></tr> </table>	CoM	1	Operate the ∧ or ∨ key until the numeric value changes to 1 (even parity).
CoM				
1				
SEL	<table border="1"> <tr><td>CoM</td></tr> <tr><td>1</td></tr> </table>	CoM	1	Press the SEL key again. The numeric value stops blinking and the setting is registered.
CoM				
1				
SEL (3 seconds)	<table border="1"> <tr><td>200</td></tr> <tr><td>200</td></tr> </table>	200	200	Press the SEL key for 3 seconds to resume the running indication (PV/SV indication).
200				
200				

5. MODBUS COMMUNICATION PROTOCOL

5.1 General

The communication system by the MODBUS protocol is that the communication is always started from the master station and a slave station responds to the received message.

Transmission procedures is as shown below.

- 1) The master station sends a command message to a slave station.
 - 2) The slave station checks that the station No. in the received message matches with the own station No. or not.
 - 3) If matched, the slave station executes the command and sends back the response message.
 - 4) If mismatched, the slave station leaves the command message and wait for the next command message.
- a) In case when the station No. in the received command message matches with the own slave station No.

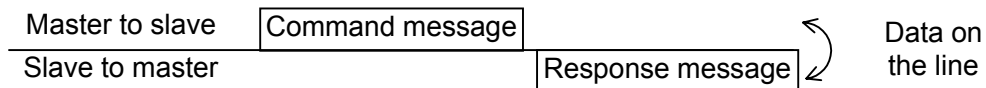

- b) In case when the station No. in the received command message mismatches with the own slave station No.

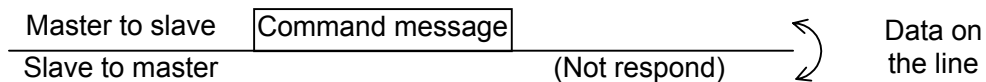

The master station can individually communicate with any one of slave stations connected on the same line upon setting the station No. in the command message.

5.2 Composition of Message

Command message and response message consist of 4 fields ; Station No., Function code, Data and Error check code. And these are send in this order.

Station No. (1 byte)
Function code (1 byte)
Data (2 to 125 bytes)
Error check code (CRC-16) (2 bytes)

Fig. 5-1 Composition of message

In the following, each field is explained.

(1) Station No.

Station No. is the number specifying a slave station. The command message is received and operated only by the slave station whose station No. matches with the No. set in the parameter "STno".

For details of setting the parameter "STno", refer to chapter 4.

(2) Function code

This is a code to designate the function executed at a slave station.

For details, refer to section 5.4.

(3) Data

Data are the data required for executing function codes. The composition of data varies with function codes. For details, refer to chapter 6.

A coil number or a register number is assigned to each data in the temperature controller. For reading/writing the data by communication, designate the coil number or register number.

Note that the coil number or register number transmitted on message is expressed as its relative address.

The relative address is calculated by the following expression.

$$\boxed{\text{Relative address}} = \left(\text{The lower 4 digits of the } \boxed{\text{Coil number or register number}} \right) - 1$$

For example, when the register number designated by a function code is 40003,

$$\begin{aligned} \text{Relative address} &= (\text{lower 4 digits of } 40003) - 1 \\ &= 0002 \end{aligned}$$

is used on the message.

(4) Error check code

This is the code to detect message errors (change in bit) in the signal transmission.

On the MODBUS protocol (RTU mode), CRC-16 (Cyclic Redundancy Check) is applied.

For CRC calculation method, refer to section 5.5.

5.3 Response of Slave Station

(1) Response for normal command

To a relevant message, the slave station creates and sends back a response message which corresponds to the command message. The composition of message in this case is the same as in section 5.2.

Contents of the data field depend on the function code. For details, refer to Chapter 6.

(2) Response for abnormal command

If contents of a command message have an abnormality (for example, non-actual function code is designated) other than transmission error, the slave station does not execute that command but creates and sends back a response message at error detection.

The composition of response message at error detection is as shown in Fig. 5-2. The value used for function code field is function code of command message plus 80_H.

Table 5-1 gives error codes.

Station No.
Function code + 80 _H
Error code
Error check (CRC-16)

Fig. 5-2 Response message at error detection

Table 5-1 Error code

Error code	Contents	Description
01H	Illegal function	Non-actual function code is designated. Check for the function code.
02H	Illegal data address	A relative address of a coil number or resistor number to which the designated function code can not be used.
03H	Illegal data value	Because the designation of number is too much, the area where coil numbers or resistor numbers do not exist is designated.

(3) No response

Under any of the following items, the slave station takes no action of the command message and sends back no response.

- A station number transmitted in the command message differs from the station number specified to the slave station.
- A error check code is not matched, or a transmission error (parity error, etc.) is detected.
- The time interval between the composition data of the message becomes longer than the time corresponding to 24 bits. (Refer to section 5.6 Transmission Control Procedure)
- While the data is being written in non-volatile memory after write via communication, the next write is attempted.

5.4 Function Code

According to MODBUS protocol, coil numbers and register numbers are assigned by function codes. Each function code acts on specific coil number and register number.

This correspondence is shown in Table 5-2, and the message length by function is shown in Table 5-3.

Table 5-2 Correspondence between function codes and objective address

Function code			Coil No. and register No.	
No.	Function	Object	No.	Contents
01 _H	Read-out (continuously)	Coil	0xxxx	Read-out/write-in bit data
02 _H	Read-out (continuously)	Input relay	1xxxx	Read-out bit data
03 _H	Read-out (continuously)	Holding register	4xxxx	Read-out/write-in word data
04 _H	Read-out (continuously)	Input register	3xxxx	Read-out word data
05 _H	Write-in	Coil	0xxxx	Read-out/write-in bit data
06 _H	Write-in	Holding register	4xxxx	Read-out/write-in word data
10 _H	Write-in (continuously)	Holding register	4xxxx	Read-out/write-in word data

Table 5-3 Function code and message length

Function code	Contents	Number of designatable data	Command message		Response message	
			Minimum	Maximum	Minimum	Maximum
01 _H	Read-out of bit data	1bit ^{*1}	8	8	6	6
02 _H	Read-out of bit data (read-out only)	8 bits ^{*1}	8	8	6	6
03 _H	Read-out of word data	60 words ^{*1}	8	8	7	125
04 _H	Read-out of word data (read-out only)	15 words ^{*1}	8	8	7	35
05 _H	Write-in of bit data	1 bit	8	8	8	8
06 _H	Write-in of word data	1 word	8	8	8	8
10 _H	Write-in of continuous word data	60 words ^{*1}	11	129	8	8

*1) The "Number of designatable data" given above is the limit due to the number of data which the instrument assigns to coil number and register number (except function codes 05_H, 06_H).

5.5 Calculation of Error Check Code (CRC-16)

CRC-16 is the 2-byte (16-bits) error check code. From the top of the message (station No.) to the end of the data field are calculated.

The slave station calculates the CRC of the received message, and does not respond if the calculated CRC is different from the contents of the received CRC code.

Fig. 5-3 shows the flow of the CRC-16 calculation system.

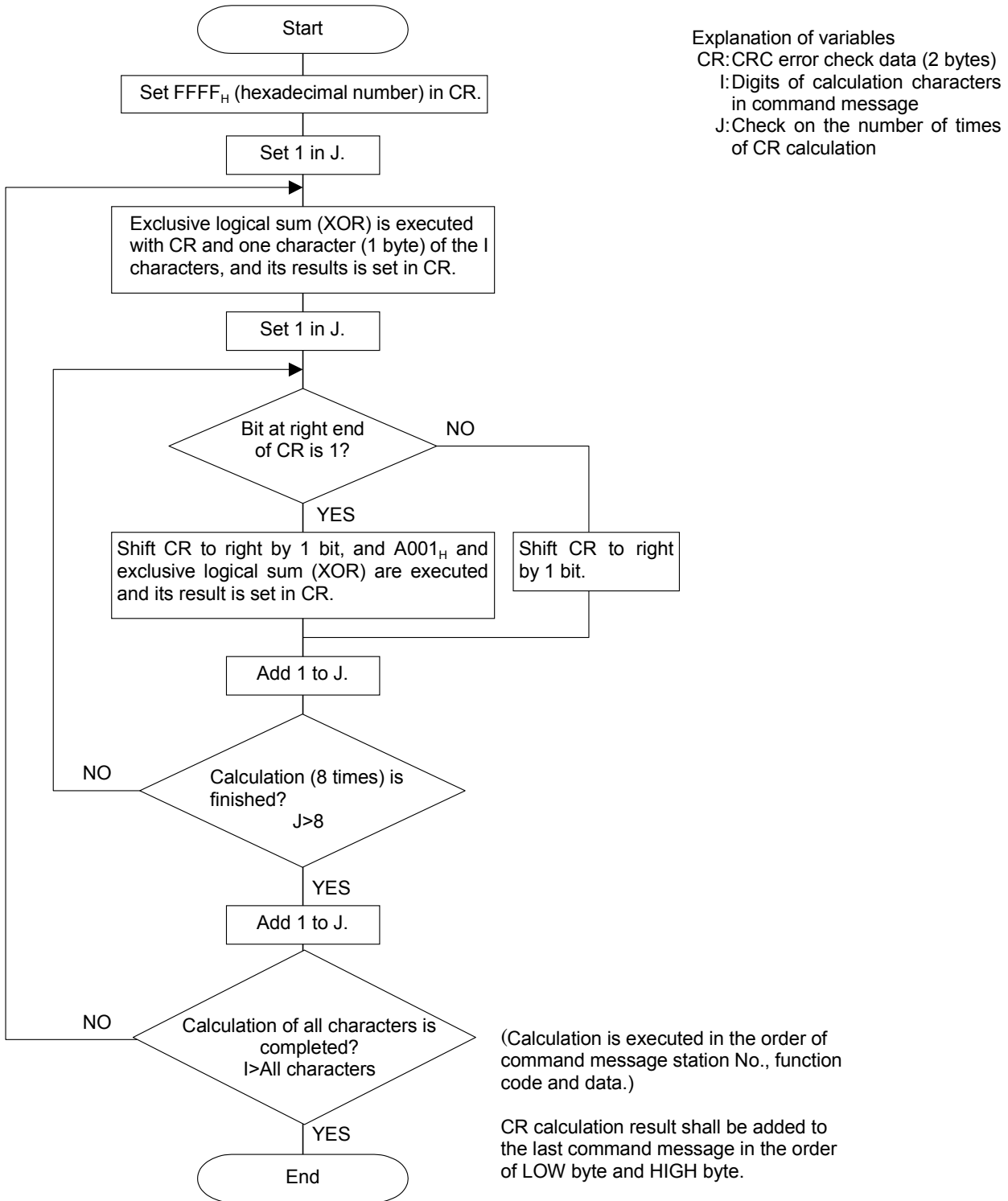

Fig. 5-3 Flow of CRC-16 calculation

5.6 Transmission Control Procedure

(1) Transmission procedure of master station

The master station must proceed to a communication upon conforming to the following items.

- (1-1) Before sending a command message, provide 48 bits time or more vacant status.
- (1-2) For sending, the interval between bytes of a command message is below 24 bits time.
- (1-3) Within 24 bits time after sending a command message, the receiving status is posted.
- (1-4) Provide 48 bits time or more vacant status between the end of response message reception and beginning of next command message sending [same as in (1-1)].
- (1-5) For ensuring the safety, make a confirmation of the response message and make an arrangement so as to provide 3 or more retries in case of no response, error occurrence, etc.

Note) The above definition is for most unfavorable value. For ensuring the safety, it's recommended the program of the master to work with safety factors of 2 to 3. Concretely, it is advised to arrange the program for 9600 bps with 10 ms or more for vacant status (1-1), and within 1 ms for byte interval (1-2) and changeover from sending to receiving (1-3).

(2) Description

1) Detection of the message frame

Since the communication system uses the 2-wire RS-485 interface, there may be 2 statuses on a line below.

- (a) Vacant status (no data on line)
- (b) Communication status (data is existing)

Instruments connected on the line are initially at a receiving status and monitoring the line. When 24 bits time or more vacant status has appeared on the line, the end of preceding frame is assumed and, within following 24 bits time, a receiving status is posted. When data appears on the line, instruments receive it while 24 bits time or more vacant status is detected again, and the end of that frame is assumed. I.e., data which appeared on the line from the first 24 bits time or more vacant status to the next 24 bits time or more vacant status is fetched as one frame.

Therefore, one frame (command message) must be sent upon confirming the following.

- (1-1) 48 bits time or more vacant status precedes the command message sending.
- (1-2) Interval between bytes of 1 command message is smaller than 24 bits time.

2) Response of this instrument (PXR)

After a frame detection (24 bits time or more vacant status), this instrument carries out processing with that frame as a command message. If the command message is destined to the own station, a response message is returned. Its processing time is 1 to 30 ms (depends on contents of command message). After sending a command message, therefore, the master station must observe the following.

- (1-3) Receiving status is posted within 24 bits time after sending a command message.

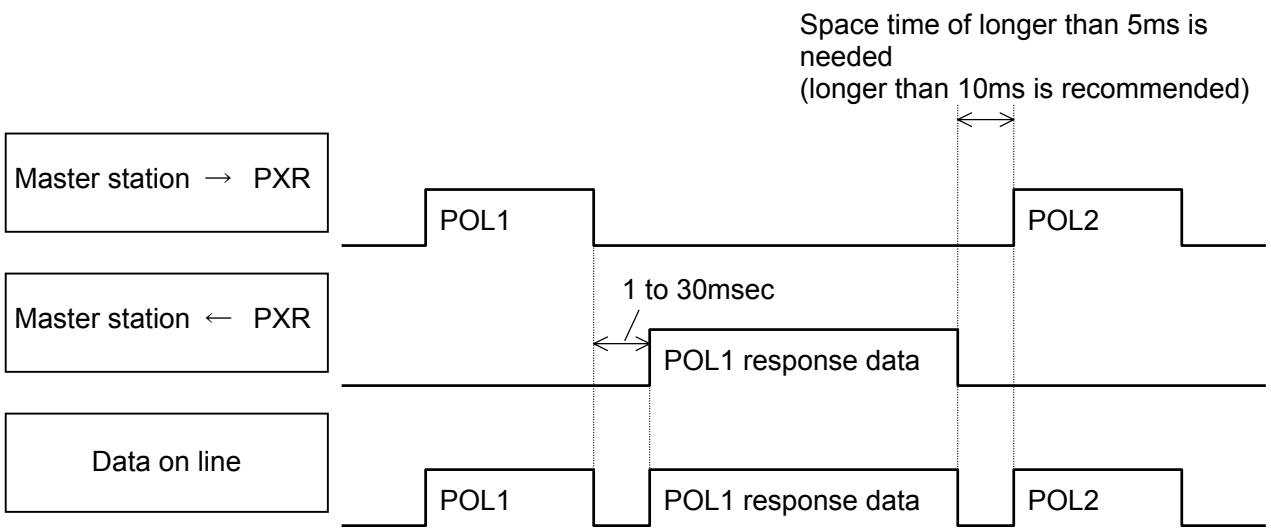

5.7 FIX Processing (Cautions at write-in of data)

The instrument is provided inside with a non-volatile memory (EEPROM) for holding the setting parameters. Data written in the non-volatile memory is not lost even if turning off the power. When setting parameter is written via communication, the data is stored in the internal memory (RAM) and then written in the non-volatile memory.

FIX execution writes the parameters stored in the internal memory into the non-volatile memory, but this function is not required any more because the data is written in non-volatile memory when it is written in the parameter.

Fig. 5-4 shows the FIX procedure.

Cautions:

- Write in the non-volatile memory takes approximately 5 seconds at the longest approximately 5 seconds.
- While writing, do not turn off the power of the PXR. Otherwise, the data in the non-volatile memory will be destroyed, whereby the PXR could not be used any longer.
- The non-volatile memory (EEPROM) is a device where the number of write-in times is limited. The guaranteed number of write-in times of the non-volatile memory used on the instrument is 10,000 minimum. Therefore, limit the times of change of parameter setting to absolute minimum. Refrain from carrying out the FIX processing periodically for example or while such is not absolutely required.

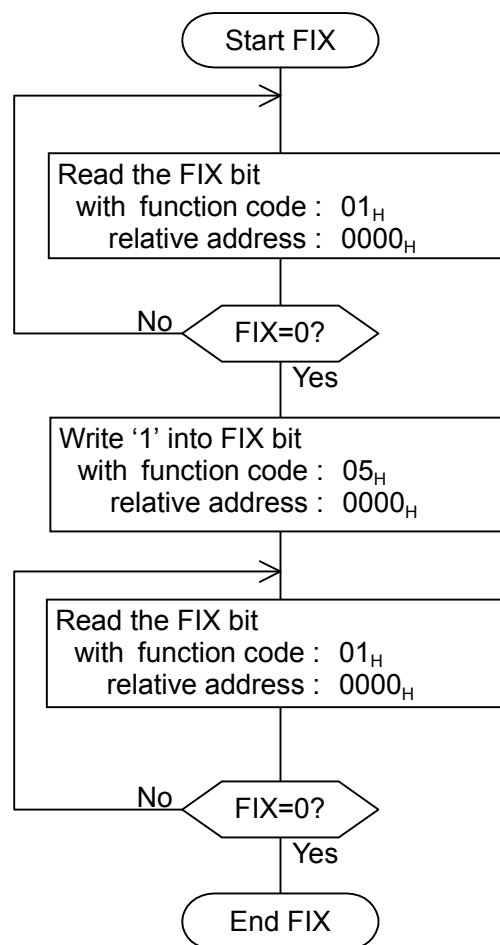

Fig. 5-4 FIX procedure

6. DETAILS OF MESSAGE

6.1 Read-out of Bit Data [Function code:01_H]

Function code	Max. bit number read-out in one message	Relative data address	Coil number
01 _H	1 bit	0000 _H	00001

(1) Message composition

Command message composition (byte)

Station No.	
Function code	
Read-out start No. (relative address)	00 _H
	00 _H
Read-out bit number	00 _H
	01 _H
CRC data	Upper
	Lower

Response message composition (byte)

Station No.	
Function code	
01 _H	
State of the first 8 bits	
CRC data	Upper
	Lower

* Arrangement of read-out bit data

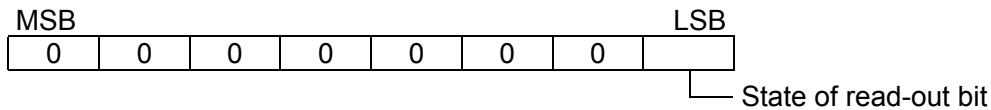

(2) Function explanations

The state of the bit of the coil No. 00001 is read-out.

(3) Message transmission (example)

The following shows an example of reading-out the FIX execution request data from No. 1 slave station.

FIX execution request bit Relative address : 0000_H Number of data : 01_H

Command message composition (byte)

Station No.	01 _H	
Function code	01 _H	
Read-out start No. (relative address)	Upper	00 _H
	Lower	00 _H
Read-out bit number	Upper	00 _H
	Lower	01 _H
CRC data	Upper	FD _H
	Lower	CA _H

Response message composition (byte)

Station No.	01 _H	
Function code	01 _H	
Read-out byte number	01 _H	
State of the first 8 bits	00 _H	
CRC data	Upper	51 _H
	Lower	88 _H

* Meaning of read data

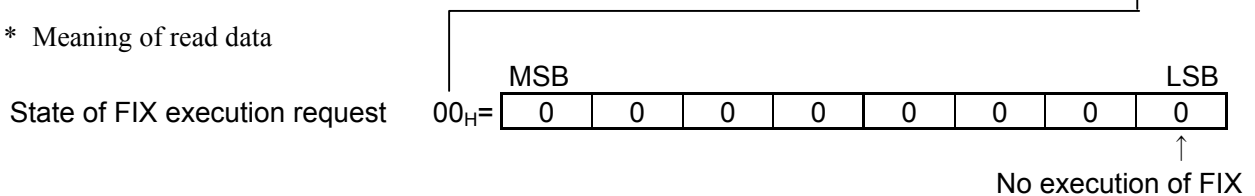

6.2 Read-out of Read-out Only Bit Data [Function code:02_H]

Function code	Max. bit number read-out in one message	Relative data address	Coil number
02 _H	8 bits	0000 _H —000F _H	10001—10016

(1) Message composition

Command message composition (byte)			Response message composition (byte)	
Station No.			Station No.	
Function code			Function code	
Read-out start No. (relative address)	Upper		01 _H	
	Lower			
Read-out bit number	00 _H	01 _H to 08 _H	State of the read-out bit	
	Lower			
CRC data	Upper		CRC data	Upper
	Lower			Lower

* Arrangement of read-out bit data

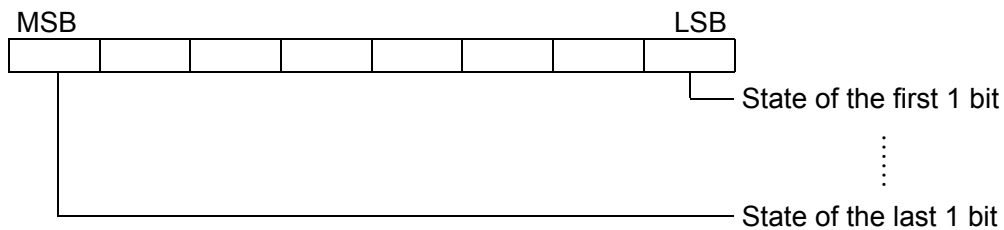

(2) Function explanations

Bit information data of continuous read-out bit number from the read-out start number.

Read-out bit data are arranged in 8-bit unit and transmitted from the slave station.

When read-out bit data number is not multiple of 8, all the bits (MSB side) not related with the state of the last 8 bits will become "0".

(3) Message transmission (example)

The following shows an example of reading-out the state of the alarm 1 and alarm 2 transmitted from No.31 slave station.

Alarm 1 detect data bit Relative address : 000C_H Data number : 02_H

Alarm 2 detect data bit Relative address : 000D_H

Command message composition (byte)

Station No.		1F _H
Function code		02 _H
Read-out start No. (relative address)	Upper	00 _H
	Lower	0C _H
Read-out bit number	Upper	00 _H
	Lower	02 _H
CRC data	Upper	3A _H
	Lower	76 _H

Response message composition (byte)

Station No.		1F _H
Function code		02 _H
Read-out byte number		01 _H
State of the first 8 bits		01 _H
CRC data	Upper	66 _H
	Lower	60 _H

* Meaning of read-out data

State of alarm detection of
alarms 1 and 2
(State of the first 2 bits)

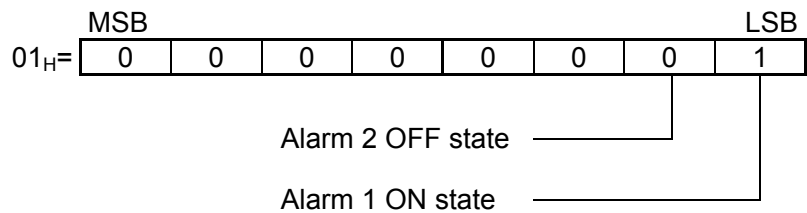

6.3 Read-out of Word Data [Function code:03_H]

Function code	Max. word number read-out in one message	Relative data address	Resister No.	Kind of data
03 _H	60 words	0000 _H —0070 _H	40001—40113	Internal calculation value
		03E8 _H —0458 _H	41001—41113	Engineering unit

(1) Message composition

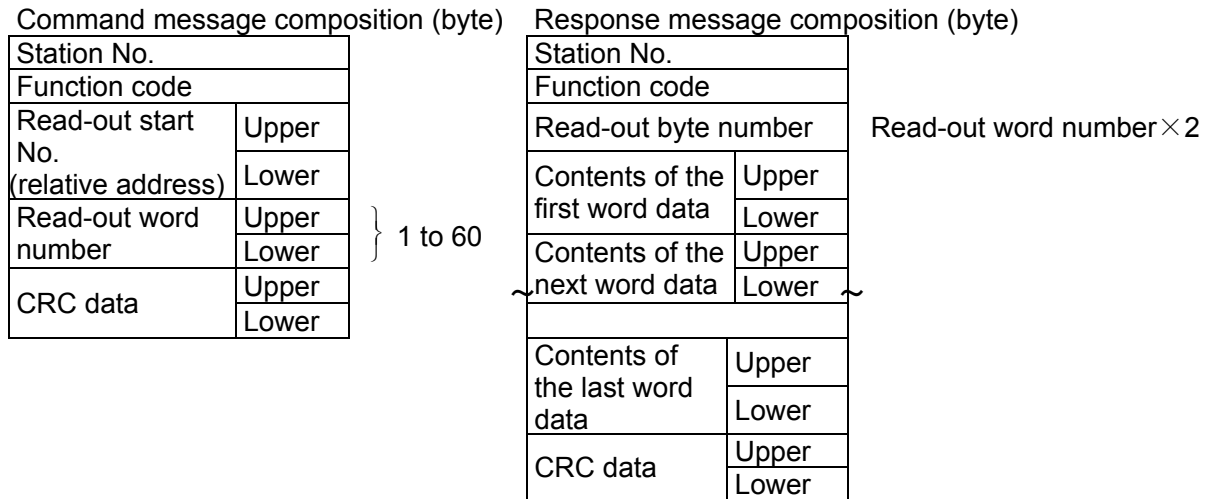

* Arrangement of read-out word data

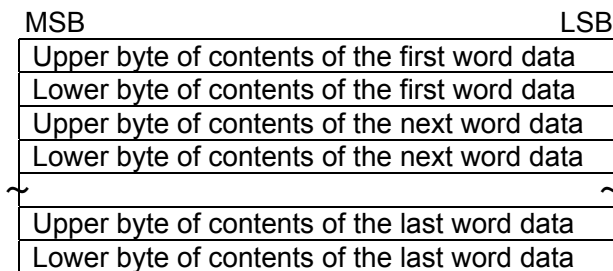

(2) Function explanations

Word data of continuous word numbers from the read-out start No. can be read. Read-out word data are transmitted from the slave station in the order of upper and lower bytes.

(3) Message transmission

(a) In case of data of internal calculation value

The following shows an example of reading the low and high limits of set value from No. 2 slave station.

Relative address of low limit of set value : 001E_H

Data number : 02_H

Command message composition (byte)

Station No.		02 _H
Function code		03 _H
Read-out start No. (relative address)	Upper	00 _H
	Lower	1E _H
Read-out word number	Upper	00 _H
	Lower	02 _H
CRC data	Upper	A4 _H
	Lower	3E _H

Response message composition (byte)

Station No.		02 _H
Function code		03 _H
Read-out byte number		04 _H
Contents of the first word data	Upper	00 _H
	Lower	00 _H
Contents of the next word data	Upper	27 _H
	Lower	10 _H
CRC data	Upper	D3 _H
	Lower	0F _H

* Meaning of read-out data

Low limit of set value 00 00_H = 0 (= 0.00%FS)
(contents of first word data)

High limit of set value 27 10_H = 10000 (=100.00%FS)
(contents of next word data)

When input range is 0 to 400°C

Low limit of set value = 0°C (= 0.00%FS)

High limit of set value =400°C (=100.00%FS)

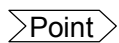

For handling of the internal calculation value, engineering unit and decimal point, refer to section 7.1.

(b) In case of data of engineering unit

The following shows an example of reading the low and high limits of set value from No. 2 slave station.

Relative address of low limit set value : 0406_H

Data number : 02_H

Command message composition (byte)

Station No.		02 _H
Function code		03 _H
Read-out start No. (relative address)	Upper	04 _H
	Lower	06 _H
Read-out word number	Upper	00 _H
	Lower	02 _H
CRC data	Upper	25 _H
	Lower	09 _H

Response message composition (byte)

Station No.		02 _H
Function code		03 _H
Read-out byte number		04 _H
Contents of the first word data	Upper	0 _H
	Lower	0 _H
Contents of the next word data	Upper	01 _H
	Lower	90 _H
CRC data	Upper	C8 _H
	Lower	CF _H

* Meaning of read-out data

Low limit of set value 00 00_H = 0
(contents of first word data)

High limit of set value 01 90_H = 400
(contents of next word data)

When the position of decimal point is 0 (Parameter P-dP=0),

Low limit of set value = 0°C

High limit of set value =400°C



For handling of the internal calculation value, engineering unit and decimal point, refer to section 7.1.

6.4 Read-out of Read-out Only Word Data [Function code:04_H]

Function code	Max. word number read-out in one message	Relative data address	Resister No.	Kind of data
04 _H	15 words	0000 _H —000E _H	30001—30015	Internal calculation value
		03E8 _H —03F6 _H	31001—31015	Engineering unit

(1) Message composition

Command message composition (byte)

Station No.	
Function code	
Read-out start No. (relative address)	Upper
	Lower
Read-out word number	Upper
	Lower
CRC data	Upper
	Lower

} 1 to 15

Response message composition (byte)

Station No.	
Function code	
Read-out byte number	
Contents of the first word data	Upper
	Lower
Contents of the next word data	Upper
	Lower
⋮	
Contents of the last word data	Upper
	Lower
CRC data	Upper
	Lower

Read-out word number × 2

* Arrangement of read-out word data

MSB	LSB
Upper byte of contents of the first word data	
Lower byte of contents of the first word data	
Upper byte of contents of the next word data	
Lower byte of contents of the next word data	
⋮	
Upper byte of contents of the last word data	
Lower byte of contents of the last word data	

(2) Function explanations

Word data of continuous word numbers from the read-out start No. can be read. Read-out word data are transmitted from the slave station in the order of upper and lower bytes.

(3) Message transmission

(a) In case of data of internal calculation value

The following shows an example of reading-out the PV from No. 1 slave station.

Relative address of PV : 0000_H

Data number : 01_H

Command message composition (byte)

Station No.		01 _H
Function code		04 _H
Read-out start No. (relative address)	Upper	00 _H
	Lower	00 _H
Read-out word number	Upper	00 _H
	Lower	01 _H
CRC data	Upper	31 _H
	Lower	CA _H

Response message composition (byte)

Station No.		01 _H
Function code		04 _H
Read-out byte number		02 _H
Contents of the first word data	Upper	03 _H
	Lower	46 _H
CRC data	Upper	38 _H
	Lower	32 _H

* Meaning of read-out data

Contents of the first word data 03 46_H = 838 (=8.38%FS)

When input range is 0-400°C,

PV=33.5°C (=8.38%FS × 400)
└─── Input range

(b) In case of data of engineering unit

The following shows an example of reading-out the PV value from No. 1 slave station.

Relative address of PV value : 03E8_H

Data number : 01_H

Command message composition (byte)

Station No.		01 _H
Function code		04 _H
Read-out start No. (relative address)	Upper	03 _H
	Lower	E8 _H
Read-out word number	Upper	00 _H
	Lower	01 _H
CRC data	Upper	B1 _H
	Lower	BA _H

Response message composition (byte)

Station No.		01 _H
Function code		04 _H
Read-out byte number		02 _H
Contents of the first word data	Upper	01 _H
	Lower	4F _H
CRC data	Upper	38 _H
	Lower	32 _H

* Meaning of read-out data

Contents of the first word data 01 4F_H = 335

When the position of decimal point is 1 (Parameter P-dP=1),

PV=33.5°C (=33.5)



For handling of the internal calculation value, engineering unit and decimal point, refer to section 7.1.

6.5 Write-in of Bit Data (1 bit) [Function code:05_H]

Function code	Max. bit number written-in one message	Relative data address	Coil No.
05 _H	1 bit	0000 _H	00001

This function has become unnecessary. (The customer can continue using the controller without changing the program.)

(1) Message composition

Command message composition (byte)			Response message composition (byte)		
Station No.			Station No.		
Function code			Function code		
Write-in designate No. (relative address)	Upper	00 _H	Write-in designate No. (relative address)	Upper	00 _H
	Lower	00 _H		Lower	00 _H
State of write-in designation	Upper	} 0000 _H =0 FF00 _H =1	State of write-in designation	Upper	} 0000 _H =0 FF00 _H =1
	Lower			Lower	
CRC data	Upper		CRC data	Upper	
	Lower			Lower	

(2) Function explanations

Data of "0" or "1" is written in a bit of write-in designation No. bit. When "0" is written-in data of 0000_H is transmitted, and when "1" is written-in, data of FF00_H is transmitted.

(3) Message transmission (example: This is the method of FIX execution)

The following shows an example of FIX execution request to No. 1 slave station.

FIX execution request bit Relative address : 0000_H

Command message composition (byte)			Response message composition (byte)		
Station No.			Station No.		
Function code			Function code		
Write-in designate No. (relative address)	Upper	00 _H	Write-in designate No. (relative address)	Upper	00 _H
	Lower	00 _H		Lower	00 _H
State of write-in designation	Upper	FF _H	State of write-in designation	Upper	FF _H
	Lower	00 _H		Lower	00 _H
CRC data	Upper	8C _H	CRC data	Upper	8C _H
	Lower	3A _H		Lower	3A _H

After receiving above command, it takes approximately 100ms to 5s seconds that PXR saves memory data from RAM to EEPROM.

Caution

If you turn off the PXR during above saving (approximately 100ms to 5s), memory data are broken and can not be used.

➤ **Point** ➤ For details of FIX processing, refer to section 5.7.

6.6 Write-in of Word Data (1 word) [Function code:06_H]

Function code	Max. word number write-in in one message	Relative data address	Resister No.	Kind of data
06 _H	1 words	0000 _H —0070 _H	40001—40113	Internal calculation value
		03E8 _H —0458 _H	41001—41113	Engineering unit

(1) Message composition

Command message composition (byte)

Station No.	
Function code	
Write-in designate No. (relative address)	Upper
	Lower
Write-in word data	Upper
	Lower
CRC data	Upper
	Lower

Response message composition (byte)

Station No.	
Function code	
Write-in designate No. (relative address)	Upper
	Lower
Write-in word data	Upper
	Lower
CRC data	Upper
	Lower

(2) Function explanation

Designated word data is written in write-in designate No. Write-in data are transmitted from master station in the order of upper and lower bytes.

(3) Message transmission (example)

The following shows an example of setting 100.0 (10000=C3E8_H) to the parameter "P" of No.1 slave station.
 Parameter "P" Relative address: 0005_H (table of internal calculation unit)
 (or 03ED_H (table of engineering value))

* Parameter "P" is not in the engineering unit setting, the same value is written in both tables.

Command message composition (byte)

Station No.		01 _H
Function code		06 _H
Write-in designate No. (relative address)	Upper	00 _H
	Lower	05 _H
State of write-in designation	Upper	03 _H
	Lower	E8 _H
CRC data	Upper	99 _H
	Lower	75 _H

} In case of interval calculation value

Response message composition (byte)

Station No.		01 _H
Function code		06 _H
Write-in designate No. (relative address)	Upper	00 _H
	Lower	05 _H
State of write-in designation	Upper	03 _H
	Lower	E8 _H
CRC data	Upper	99 _H
	Lower	75 _H



For handling of internal calculation value, engineering unit and decimal point, refer to section 7.1.

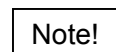

- 1)While setting is being locked, response is returned normally, but the command is not executed.
- 2)While the data is written in non-volatile memory, response is not returned.

6.7 Write-in of Continuous Word Data [Function code:10_H]

Function code	Max. word number write-in in one message	Relative data address	Resister No.	Kind of data
10 _H	60 words	0000 _H —0070 _H	40001—40113	Internal calculation value
		03E8 _H —0458 _H	41001—41113	Engineering unit

(1) Message composition

Command message composition (byte)

Station No.	
Function code	
Write-in start No. (relative address)	Upper
	Lower
Write-in word number	Upper
	Lower
Write-in byte number	
First write-in word data	Upper
	Lower
Next write-in word data	Upper
	Lower
~	
Last write-in word data	Upper
	Lower
CRC data	Upper
	Lower

} 1 to 60

} Write-in word number × 2

Response message composition (byte)

Station No.	
Function code	
Write-in start No. (relative address)	Upper
	Lower
Write-in word number	Upper
	Lower
CRC data	Upper
	Lower

* Arrangement of write-in word data

MSB	LSB
Upper byte of contents of the first word data	
Lower byte of contents of the first word data	
Upper byte of contents of the next word data	
Lower byte of contents of the next word data	
~	
Upper byte of contents of the last word data	
Lower byte of contents of the last word data	

(2) Function explanation

Word data of continuous word number is written from write-in start address. Write-in word data are transmitted from master station in the order of upper and lower bytes.

(3) Message transmission (example)

The following shows an example of writing-in P=100.0, I=10, and D=5.0 to No. 1 slave station.

P=03E8_H (=1000_D)

I=0064_H (=100_D)

D=0032_H (=50_D)

Parameter "P" Relative address:0005_H Data number:03_H

Command message composition (byte)

Station No.		01 _H
Function code		10 _H
Write-in start No.	Upper	00 _H
	Lower	05 _H
Write-in word number	Upper	00 _H
	Lower	03 _H
Write-in byte number		06 _H
First write-in word data	Upper	03 _H
	Lower	E8 _H
Next write-in word data	Upper	00 _H
	Lower	64 _H
Last write-in word data	Upper	00 _H
	Lower	32 _H
CRC data	Upper	56 _H
	Lower	BE _H

Response message composition (byte)

Station No.		01 _H
Function code		10 _H
Write-in start No.	Upper	00 _H
	Lower	05 _H
Write-in word number	Upper	00 _H
	Lower	03 _H
CRC data	Upper	90 _H
	Lower	09 _H

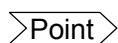

Since the transmission data can not include a decimal point, data of 100.0 is transmitted as "1000".

For transmission format of each data, refer to the address map (Chapter 7).

7. ADDRESS MAP AND DATA FORMAT

7.1 Data Format

7.1.1 Transmission data format

The MODBUS protocol used in this instrument (PXR) is RTU (Remote Terminal Unit) mode. Transmitted data is "numeric value" and not "ASCII code".

7.1.2 Internal calculation value and engineering unit

This instrument can handle 2 kinds of set value data or other data which are affected by input range as follows.

- 1) Internal calculation value : In % with respect to input range (0.00 to 100.00, without decimal point)
- 2) Engineering unit : Subjected to scaling to actual value according to input range

"Engineering unit" data can be handled with "Internal calculation value" address (register No.) plus 1,000

[Example] The value of "PV = 150" (input range: 0 to 400°C)

	Register No.	Data (HEX)		Data (decimal)
Internal calculation value	30001	0EA6H	➔	3750 (37.50%)
Engineering unit	31001	0096H		150

In case of "Internal calculation value" here,

$$37.50 (\%) \times 400 (\text{full scale}) = 150 (^\circ\text{C}) \quad \text{is obtained.}$$

Note that the same data is handled at both addresses if it is not affected by input range.

This handling does not apply to bit data. (Address increased by 1,000 is invalid.)

For data affected by input range, refer to address maps in Sections 7.2 and 7.3.

Note : After changing the input range by communication write-in, pay attention to the decimal point position. After changing the decimal point position by communication write-in, simultaneously change the lower limit and upper limit of input range.

Example: Input range 0 to 400 changed into 0.0 to 400.0

- | | | | |
|----------------------------|-------------------|---|--------------------|
| a) Face panel operation: | P-dP=0→1 suffices | } | must be performed. |
| b) Communication write-in: | P-dP=0→1 | | |
| | P-SL=0→0 | | |
| | P-SU=400→4000 | | |

7.1.3 Handling of decimal point

Some internally stored data have more digits below decimal point than displayed on the face panel.

No decimal point is added to transmission data.

For data given in the following table, carry out an alignment of decimal point.

(a) Internal calculation value data (address map shown in Section 7.2)

Digits below point	Kind	Resister No.
Designate by parameter [P-dP] (0 to 2)	Parameter [P-SL]	40018
	Parameter [P-SU]	40019
1 digit below point	Parameter [P]	40006
	Parameter [i]	40007
	Parameter [d]	40008
	Parameter [CooL]	40010
	Parameter [P-dF]	40022
	Parameter [HB]	40039
	Parameter [CT]	30010
2 digits below point	Data affected by input range	See address map (Section 7.2)
	Parameter [dB]	40011
	Parameter [bAL]	40013
	Parameter [PLC1]	40025
	Parameter [PHC1]	40026
	Parameter [PLC2]	40027
	Parameter [PHC2]	40028
	Parameter [OUT1]	30004
	Parameter [OUT2]	30005

(b) Engineering unit (address map shown in Section 7.3)

Digits below point	Kind	Resister No.
Designate by parameter [P-dP] (0 to 2)	Parameter [P-SL]	41018
	Parameter [P-SU]	41019
	Data affected by input range	See address map (Section 7.3)
1 digit below point	Parameter [P]	41006
	Parameter [i]	41007
	Parameter [d]	41008
	Parameter [CooL]	41010
	Parameter [P-dF]	41022
	Parameter [HB]	41039
	Parameter [CT]	31010
2 digits below point	Parameter [dB]	41011
	Parameter [bAL]	41013
	Parameter [PLC1]	41025
	Parameter [PHC1]	41026
	Parameter [PLC2]	41027
	Parameter [PHC2]	41028
	Parameter [OUT1]	31004
	Parameter [OUT2]	31005

7.1.4 Data when input is abnormal

When "UUUU" or "LLLL" is displayed on the face panel on account of over-range, under-range or input open-circuit for example, PV read-out value is 105% or -5% of input range.

Presence of any input abnormality via communication can be detected by:

"Register No. 30008 (or 31008): Input/main unit abnormal status"

7.2 Address Map of Internal Calculation Value Data

Data affected by input range is handled in terms of internal value (0.00 to 100.00% value) before scaling.

For detailed contents about individual parameter function or setting range, refer to the operation manual (ECNO: 406).

Bit data [read-out/write-in] : Function code [01_H, 05_H]

Relative address	Coil No.	Type	Memory contents	Read-out data	Write-in data setting range	Affected by input range	Remarks or corresponding parameter
0000 _H	00001	Bit	Write in non-volatile memory (FIX execution)	0:Not writing-in 1:Writing in memory	0:No request 1:Request to write in		(the same function as 40001)

Bit data [read-out only] : Function code [02_H]

Relative address	Coil No.	Type	Memory contents	Read-out data	Affected by input range	Remarks or corresponding parameter
0000 _H	10001	Bit	Alarm 1 ON/OFF	0:Alarm 1 OFF, 1: Alarm 1 ON		
0001 _H	10002		(Reserve)			
0002 _H	10003		(Reserve)			
0003 _H	10004		(Reserve)			
0004 _H	10005	Bit	Alarm 2 ON/OFF	0: Alarm 2 OFF, 1: Alarm 2 ON		
0005 _H	10006		(Reserve)			
0006 _H	10007		(Reserve)			
0007 _H	10008		(Reserve)			
0008 _H	10009	Bit	Alarm 1 output (Calculation result of non-exciting alarm)	0: Relay output of alarm 1 OFF 1: Relay output of alarm 1 ON		
0009 _H	10010	Bit	Alarm 2 output (Calculation result of non-exciting alarm)	0: Relay output of alarm 2 OFF 1: Relay output of alarm 2 ON		
000A _H	10011		(Reserve)			
000B _H	10012	Bit	HB alarm relay output	0: HB alarm output OFF 1: HB alarm output ON		
000C _H	10013	Bit	Alarm 1 ON/OFF	0: Alarm 1 OFF, 1: Alarm 1 ON		(Same as 10001)
000D _H	10014	Bit	Alarm 2 ON/OFF	0: Alarm 2 OFF, 1: Alarm 2 ON		(Same as 10002)
000E _H	10015		(Reserve)			
000F _H	10016	Bit	HB alarm relay output	0:HB alarm output OFF 1:HB alarm output ON		(Same as 10012)

Word data [read-out/write-in] : Function code [03_H, 06_H, 10_H]

Relative address	Resister No.	Type	Memory contents	Read-out data	Write-in data setting range	Affected by input range	Remarks or corresponding parameter
0000 _H	40001	Word	Non-volatile memory write-in	0: Not writing-in 1: Writing in memory	0:No request 1:Request to write in		(Same function as 00001)
0001 _H	40002	Word	PID/FUZZY/SELF selection	0:PID control 1:FUZZY control 2:SELF tuning control			CTrL * Inhibit change while controlling
0002 _H	40003	Word	SV value set on face panel	0 to 10000 (within 0.00 to 100.00% FS within set value limits)		*	
0003 _H	40004	Word	Control RUN/standby	0: Invalidate standby (RUN) 1: Validate standby			STby
0004 _H	40005	Word	Auto tuning command	0: Auto tuning disabled 1: While executing standard type AT executed 2: While executing low PV type AT executed	0: Disable auto tuning 1: Request execution of standard type 2: Request execution of low PV type AT		AT
0005 _H	40006	Word	P	0 to 9999 (0.0 to 999.9%)			P
0006 _H	40007	Word	I	0 to 32000 (0 to 3200.0 sec)			i
0007 _H	40008	Word	D	0 to 9999 (0.0 to 999.9 sec)			D
0008 _H	40009	Word	Hysteresis range at two-position control	0 to 5000 (0.00 to 50.00%FS)		*	HyS
0009 _H	40010	Word	COOL	0 to 1000 (0.0 to 100.0)			CoolL
000A _H	40011	Word	Dead band	-5000 to 5000 (-50.00 to +50.00)			db
000B _H	40012	Word	Anti-reset windup	0 to 10000 (0.00 to 100.00%)		*	Ar
000C _H	40013	Word	Output convergence value	-10000 to 10000 (-100.00 to 100.00%)			bAL
000D _H	40014	Word	PV shift	-1000 to 1000 (-10.00 to 10.00%FS)		*	PVOF
000E _H	40015	Word	SV offset	-5000 to 5000 (-50.00 to 50.00%FS)		*	SVOF
000F _H	40016	Word	Input type code	0 to 16			P-n2
0010 _H	40017	Word	Temperature unit	0:°C 1:°F			P-F
0011 _H	40018	Word	Input scale lower limit	-1999 to 9999			P-SL
0012 _H	40019	Word	Input scale upper limit	-1999 to 9999			P-SU
0013 _H	40020	Word	Decimal point place	0 to 2			P-dP
0014 _H	40021		(Do not use)				
0015 _H	40022	Word	Input filter time constant	0 to 9000 (0.0 to 900.0 sec)			P-dF
0016 _H	40023	Word	RCJ yes/no	0: Disable RCJ compensation (do not perform reference cold junction compensation) 1: Enable RCJ compensation (perform reference cold junction compensation)			rCJ
0017 _H	40024	Word	MV limit kind	0 to 15			PCUT
0018 _H	40025	Word	Output 1 lower limit	-300 to 10300 (-3.00 to 103.00%)			PLC1
0019 _H	40026	Word	Output 1 upper limit	-300 to 10300 (-3.00 to 103.00%)			PHC1
001A _H	40027	Word	Output 2 lower limit	-300 to 10300 (-3.00 to 103.00%)			PLC2
001B _H	40028	Word	Output 2 upper limit	-300 to 10300 (-3.00 to 103.00%)			PHC2
001C _H	40029		(Do not use)				
001D _H	40030		(Do not use)				
001E _H	40031	Word	Set value (SV) lower limit	0 to 10000 (0.00 to 100.00%FS)		*	SV-L
001F _H	40032	Word	Set value (SV) upper limit	0 to 10000 (0.00 to 100.00%FS)		*	SV-H
0020 _H	40033		(Do not use)				
0021 _H	40034		(Do not use)				
0022 _H	40035		(Do not use)				
0023 _H	40036		(Do not use)				
0024 _H	40037		(Do not use)				
0025 _H	40038		(Do not use)				
0026 _H	40039	Word	Heater burnout alarm set value	0 to 500 (0.0 to 50.0A)			Hb
0027 _H	40040	Word	Setting lock	0 to 5			LoC

Relative address	Resister No.	Type	Memory contents	Read-out data	Write-in data setting range	Affected by input range	Remarks or corresponding parameter	
0028 _H	40041	Word	Alarm 1 type	0 to 34			ALM1	
0029 _H	40042	Word	Alarm 2 type	0 to 34			ALM2	
002A _H	40043		(Do not use)					
002B _H	40044	Word	Alarm 1 set value or alarm 1 lower limit set value	For absolute value alarm 0 to 10000 (0.00 to 100.00%FS)		*	AL1 or A1-L	
002C _H	40045	Word	Alarm 2 set value or alarm 2 lower limit set value	For deviation alarm -10000 to 10000 (-100.00 to 100.00%FS)		*	AL2 or A2-L	
002D _H	40046		(Do not use)					
002E _H	40047	Word	Alarm 1 upper limit set value	For absolute value alarm 0 to 10000 (0.00 to 100.00%FS)		*	A1-H	
002F _H	40048	Word	Alarm 2 upper limit set value	For deviation alarm -10000 to 10000 (-100.00 to 100.00%FS)		*	A2-H	
0030 _H	40049		(Do not use)					
0031 _H	40050	Word	Alarm 1 hysteresis	0 to 5000 (0.00 to 50.00%FS)		*	A1hy	
0032 _H	40051	Word	Alarm 2 hysteresis	0 to 5000 (0.00 to 50.00%FS)		*	A2hy	
0033 _H	40052		(Do not use)					
0034 _H	40053	Word	Alarm 1 ON-delay set value	0 to 9999 (0 to 9999 sec)			dLy1	
0035 _H	40054	Word	Alarm 2 ON-delay set value	0 to 9999 (0 to 9999 sec)			dLy2	
0036 _H	40055		(Do not use)					
0037 _H	40056		(Do not use)					
0038 _H	40057	Word	Ramp/soak No. 1 target value	0 to 10000 (0.00 to 100.00%FS, within set value limit)		*	Sv-1	
0039 _H	40058	Word	Ramp/soak No. 2 target value			*	Sv-2	
003A _H	40059	Word	Ramp/soak No. 3 target value			*	Sv-3	
003B _H	40060	Word	Ramp/soak No. 4 target value			*	Sv-4	
003C _H	40061	Word	Ramp/soak No. 5 target value			*	Sv-5	
003D _H	40062	Word	Ramp/soak No. 6 target value			*	Sv-6	
003E _H	40063	Word	Ramp/soak No. 7 target value			*	Sv-7	
003F _H	40064	Word	Ramp/soak No. 8 target value			*	Sv-8	
0040 _H	40065	Word	Ramp/soak No. 1 ramp time	0 to 5999 (0 to 5999 min) * With main unit parameter, Hour Minute is displayed and set. Therefore, correspondence occurs as: 3601:Data via communication 6001:Display/setting on main unit			TM1r	
0041 _H	40066	Word	Ramp/soak No. 1 soak time					TM1S
0042 _H	40067	Word	Ramp/soak No. 2 ramp time					TM2r
0043 _H	40068	Word	Ramp/soak No. 2 soak time					TM2S
0044 _H	40069	Word	Ramp/soak No. 3 ramp time					TM3r
0045 _H	40070	Word	Ramp/soak No. 3 soak time					TM3S
0046 _H	40071	Word	Ramp/soak No. 4 ramp time					TM4r
0047 _H	40072	Word	Ramp/soak No. 4 soak time					TM4S
0048 _H	40073	Word	Ramp/soak No. 5 ramp time					TM5r
0049 _H	40074	Word	Ramp/soak No. 5 soak time					TM5S
004A _H	40075	Word	Ramp/soak No. 6 ramp time					TM6r
004B _H	40076	Word	Ramp/soak No. 6 soak time					TM6S
004C _H	40077	Word	Ramp/soak No. 7 ramp time					TM7r
004D _H	40078	Word	Ramp/soak No. 7 soak time					TM7S
004E _H	40079	Word	Ramp/soak No. 8 ramp time					TM8r
004F _H	40080	Word	Ramp/soak No. 8 soak time					TM8S
0050 _H	40081	Word	Ramp/soak mode	0 to 15			MOD	
0051 _H	40082	Word	Ramp/soak command	0: oFF Ramp/soak stopped 1: rUn Ramp/soak operated 2: HLd Ramp/soak halted 3: End Ramp/soak ended	0: oFF Stop ramp/soak 1: rUn Start ramp/soak 2: HLd Halt ramp/soak		ProG	

Note

Relative address	Resister No.	Type	Memory contents	Read-out data	Write-in data setting range	Affected by input range	Remarks or corresponding parameter
0052 _H	40083	Word	Ramp/soak pattern selection	0: Execute No. 1 to 4 ramp/soak (PTn=1) 1: Execute No. 5 to 8 ramp/soak (PTn=2) 2: Execute No. 1 to 8 ramp/soak (PTn=3)			PTn
0053 _H	40084		(Do not use)				
0054 _H	40085	Word	PV stable range	0 to 10000 (0.00 to 100.00%FS)		*	SLFb
0055 _H	40086		(Do not use)				
0056 _H	40087	Word	Communication DI action request	*② (refer to section 7.4.)			
0057 _H	40088	Word	Control action type code	0 to 19			P-n1
0058 _H	40089	Word	Output proportional cycle (output 1)	0: Current output type 1 to 150 (1 to 150 sec) : Relay, SSR drive output type			TC
0059 _H	40090	Word	Output proportional cycle (output 2)	1 to 150 (1 to 150 sec)			TC2
005A _H	40091		(Do not use)				
005B _H	40092	Word	Alarm 1 option function	0 to 7 (binary data 000 _B to 111 _B)			A1op
005C _H	40093	Word	Alarm 2 option function	0 to 7 (binary data 000 _B to 111 _B)			A2op
005D _H	40094		(Do not use)				
005E _H	40095	Word	DI1 action setting	0 to 12			di-1
005F _H	40096		(Do not use)				
0060 _H	40097	Word	Hysteresis mode setting	0: off (main unit parameter setting) 1: on (main unit parameter setting)			ONOF
0061 _H	40098	Word	(Do not use)				
0062 _H	40099	Word	User zero adjustment	-5000 to 5000 (-50.00 to 50.00%FS)		*	ADJ0
0063 _H	40100	Word	User span adjustment	-5000 to 5000 (-50.00 to 50.00%FS)		*	ADJS
0064 _H	40101	Word	DSP1 (parameter mask designation)	0 to 255			dSP1
0065 _H	40102	Word	DSP2 (parameter mask designation)	0 to 255			dSP2
0066 _H	40103	Word	DSP3 (parameter mask designation)	0 to 255			dSP3
0067 _H	40104	Word	DSP4 (parameter mask designation)	0 to 255			dSP4
0068 _H	40105	Word	DSP5 (parameter mask designation)	0 to 255			dSP5
0069 _H	40106	Word	DSP6 (parameter mask designation)	0 to 255			dSP6
006A _H	40107	Word	DSP7 (parameter mask designation)	0 to 255			dSP7
006B _H	40108	Word	DSP8 (parameter mask designation)	0 to 255			dSP8
006C _H	40109	Word	DSP9 (parameter mask designation)	0 to 255			dSP9
006D _H	40110	Word	DSP10 (parameter mask designation)	0 to 255			dSP10
006E _H	40111	Word	DSP11 (parameter mask designation)	0 to 255			dSP11
006F _H	40112	Word	DSP12 (parameter mask designation)	0 to 255			dSP12
0070 _H	40113	Word	DSP13 (parameter mask designation)	0 to 255			dSP13

Note) Read-out/write-in data from Resister No. 40083 (ramp/soak pattern selection) correspond to parameter “PTn” to be displayed as shown below:

Read-out/write-in data	Parameter PTn	Contents
0	1	1 to 4 ramp/soak executed
1	2	5 to 8 ramp/soak executed
2	3	1 to 8 ramp/soak executed

Word data (read-out only) : Function code [04_H]

Relative address	Resister No.	Type	Memory contents	Read-out data	Affected by input range	Remarks or corresponding parameter
0000 _H	30001	Word	Process value (PV)	0 to 10000 (0.00 to 100.00%FS)	*	(Displayed PV value)
0001 _H	30002	Word	Currently used set value (SV)	0 to 10000 (0.00 to 100.00%FS)	*	(Displayed SV value)
0002 _H	30003	Word	Currently used deviation (DV)	-10000 to 10000 (-100.00 to 100.00%FS)	*	
0003 _H	30004	Word	MV (output 1)	-300 to 10300 (-3.00 to 103.00%)		OUT1
0004 _H	30005	Word	MV (output 2)	-300 to 10300 (-3.00 to 103.00%)		OUT2
0005 _H	30006	Word	Station No.	0 to 255		STno
0006 _H	30007	Word	Alarm status	*③ (refer to Section 7.4.)		
0007 _H	30008	Word	Input/main unit abnormal status	*④ (refer to Section 7.4.)		
0008 _H	30009	Word	Ramp/soak current running position	0 to 17 *⑥ (refer to Section 7.4.)		STAT
0009 _H	30010	Word	Heater current	0 to 500 (0.0 to 50.0A)		CT
000A _H	30011	Word	Timer 1 current count	0 to 9999 (0 to 9999 sec)		TM-1
000B _H	30012	Word	Timer 2 current count	0 to 9999 (0 to 9999 sec)		TM-2
000C _H	30013		(Reserve)			
000D _H	30014		(Reserve)			
000E _H	30015	Word	DI action status	*⑤ (refer to Section 7.4.)		

Notes)

- For details of * ② to * ⑥ in the table, refer to Section 7.4.
- The area marked (Do not use) is a reserve area. Do not write in there.
- Register numbers 30002 (currently used SV) and 40003 (face panel set SV) do not become the same value while switching-SV is active or ramp/soak is under way. (Example: While SV-1 is selected, the value of SV-1 is read out of register number 30002.) For reading out SV for monitoring, use SV in register number 30002.

7.3 Address Map of Engineering Unit Data

Data affected by input range is handled in terms of a value (engineering unit) after scaling.

For detailed contents about individual parameter function or setting range, refer to the operation manual (ECNO: 406).

Bit data [read-out/write-in] : Function code [01_H, 05_H]

Relative address	Coil No.	Type	Memory contents	Read-out data	Write-in data setting range	Affected by input range	Remarks or corresponding parameter
0000 _H	00001	Bit	Write in non-volatile memory (FIX execution)	0:Not Writing-in 1:Writing in memory	0:No request 1:Write-in request		(the same function as 40001)

Bit data [read-out only] : Function code [02_H]

Relative address	Coil No.	Type	Memory contents	Read-out data	Affected by input range	Remarks or corresponding parameter
0000 _H	10001	Bit	Alarm 1 ON/OFF	0:Alarm 1 OFF, 1: Alarm 1 ON		
0001 _H	10002		(Reserve)			
0002 _H	10003		(Reserve)			
0003 _H	10004		(Reserve)			
0004 _H	10005	Bit	Alarm 2 ON/OFF	0: Alarm 2 OFF, 1: Alarm 2 ON		
0005 _H	10006		(Reserve)			
0006 _H	10007		(Reserve)			
0007 _H	10008		(Reserve)			
0008 _H	10009	Bit	Alarm 1 output (Calculation result of non-exciting alarm)	0: Relay output of alarm 1 OFF 1: Relay output of alarm 1 ON		
0009 _H	10010	Bit	Alarm 2 output (Calculation result of non-exciting alarm)	0: Relay output of alarm 2 OFF 1: Relay output of alarm 2 ON		
000A _H	10011		(Reserve)			
000B _H	10012	Bit	HB alarm relay output	0: HB alarm output OFF 1: HB alarm output ON		
000C _H	10013	Bit	Alarm 1 ON/OFF	0: Alarm 1 OFF, 1: Alarm 1 ON		(Same as 10001)
000D _H	10014	Bit	Alarm 2 ON/OFF	0: Alarm 2 OFF, 1: Alarm 2 ON		(Same as 10002)
000E _H	10015		(Reserve)			
000F _H	10016	Bit	HB alarm relay output	0:HB alarm output OFF 1:HB alarm output ON		(Same as 10012)

Word data [read-out/write-in]: Function code [03_H, 06_H, 10_H]

Relative address	Resister No.	Type	Memory contents	Read-out data	Write-in data setting range	Affected by input range	Remarks or corresponding parameter
03E8 _H	41001	Word	Non-volatile memory write-in (FIX execution)	0: Not writing in 1: Write in memory	0: No request 1: Request to write in		(Same function as 00001)
03E9 _H	41002	Word	PID/FUZZY/SELF selection	0: PID control 1: FUZZY control 2: SELF tuning control			CTrL * Inhibit change while controlling
03EA _H	41003	Word	SV value controlled on face panel	-1999 to 9999 (within set value limits)		*	
03EB _H	41004	Word	Control RUN/standby	0: Invalidate standby (RUN) 1: Validate standby			STby
03EC _H	41005	Word	Auto tuning command	0: Auto tuning disabled 1: While executing standard type AT executed 2: While executing low PV type AT executed	0: Disable auto tuning 1: Request execution of standard type 2: Request execution of low PV type AT		AT
03ED _H	41006	Word	P	0 to 9999 (0.0 to 999.9%)			P
03EE _H	41007	Word	I	0 to 32000 (0 to 3200.0 sec)			i
03EF _H	41008	Word	D	0 to 9999 (0.0 to 999.9 sec)			D
03F0 _H	41009	Word	Hysteresis range at two-position control	0 to 9999 (0 to 50% value of input scale)		*	HyS
03F1 _H	41010	Word	COOL	0 to 1000 (0.0 to 100.0)			Cool
03F2 _H	41011	Word	Dead band	-5000 to 5000 (-50.00 to +50.00%)			db
03F3 _H	41012	Word	Anti-reset windup	-1999 to 9999 (0 to 100% value of input scale)		*	Ar
03F4 _H	41013	Word	Output convergence value	-10000 to 10000 (-100.00 to 100.00%)			bAL
03F5 _H	41014	Word	PV shift	-1999 to 9999 (-10 to 10% value of input scale)		*	PVOF
03F6 _H	41015	Word	SV offset	-1999 to 9999 (-50 to 50% value of input scale)		*	SVOF
03F7 _H	41016	Word	Input type code	0 to 16			P-n2
03F8 _H	41017	Word	Temperature unit	0: °C 1: °F			P-F
03F9 _H	41018	Word	Input scale lower limit	-1999 to 9999			P-SL
03FA _H	41019	Word	Input scale upper limit	-1999 to 9999			P-SU
03FB _H	41020	Word	Decimal point place	0 to 2			P-dP
03FC _H	41021		(Do not use)				
03FD _H	41022	Word	Input filter time constant	0 to 9000 (0.0 to 900.0 sec)			P-dF
03FE _H	41023	Word	RCJ yes/no	0: Disable RCJ compensation (do not perform reference cold junction compensation) 1: Enable RCJ compensation (perform reference cold junction compensation)			rCJ
03FF _H	41024	Word	MV limit kind	0 to 15			PCUT
0400 _H	41025	Word	Output 1 lower limit	-300 to 10300 (-3.00 to 103.00%)			PLC1
0401 _H	41026	Word	Output 1 upper limit	-300 to 10300 (-3.00 to 103.00%)			PHC1
0402 _H	41027	Word	Output 2 lower limit	-300 to 10300 (-3.00 to 103.00%)			PLC2
0403 _H	41028	Word	Output 2 upper limit	-300 to 10300 (-3.00 to 103.00%)			PHC2
0404 _H	41029		(Do not use)				
0405 _H	41030		(Do not use)				
0406 _H	41031	Word	Set value (SV) lower limit	-1999 to 9999 (within input scale)		*	SV-L
0407 _H	41032	Word	Set value (SV) upper limit	-1999 to 9999 (within input scale)		*	SV-H
0408 _H	41033		(Do not use)				
0409 _H	41034		(Do not use)				
040A _H	41035		(Do not use)				
040B _H	41036		(Do not use)				
040C _H	41037		(Do not use)				
040D _H	41038		(Do not use)				
040E _H	41039	Word	Heater burnout alarm set value	0 to 500 (0.0 to 50.0A)			Hb

Relative address	Resister No.	Type	Memory contents	Read-out data	Write-in data setting range	Affected by input range	Remarks or corresponding parameter
040F _H	41040	Word	Setting lock	0 to 5			LoC
0410 _H	41041	Word	Alarm 1 type	0 to 34			ALM1
0411 _H	41042	Word	Alarm 2 type	0 to 34			ALM2
0412 _H	41043		(Do not use)				
0413 _H	41044	Word	Alarm 1 set value or alarm 1 lower limit set value	-1999 to 9999 For absolute value alarm: 0 to 100% value of input scale		*	AL1 or A1-L
0414 _H	41045	Word	Alarm 2 set value or alarm 2 lower limit set value	For deviation alarm: -100 to 100% value of input scale		*	AL2 or A2-L
0415 _H	41046		(Do not use)				
0416 _H	41047	Word	Alarm 1 upper limit set value	-1999 to 9999 For absolute value alarm: 0 to 100% value of input scale		*	A1-H
0417 _H	41048	Word	Alarm 2 upper limit set value	For deviation alarm: -100 to 100% value of input scale		*	A2-H
0418 _H	41049		(Do not use)				
0419 _H	41050	Word	Alarm 1 hysteresis	0 to 9999 (0 to 50% value of input scale)		*	A1hy
041A _H	41051	Word	Alarm 2 hysteresis	0 to 9999 (0 to 50% value of input scale)		*	A2hy
041B _H	41052		(Do not use)				
041C _H	41053	Word	Alarm 1 ON-delay set value	0 to 9999 (0 to 9999 sec)			dLy1
041D _H	41054	Word	Alarm 2 ON-delay set value	0 to 9999 (0 to 9999 sec)			dLy2
041E _H	41055		(Do not use)				
041F _H	41056		(Do not use)				
0420 _H	41057	Word	Ramp/soak No. 1 target value			*	Sv-1
0421 _H	41058	Word	Ramp/soak No. 2 target value			*	Sv-2
0422 _H	41059	Word	Ramp/soak No. 3 target value			*	Sv-3
0423 _H	41060	Word	Ramp/soak No. 4 target value	-1999 to 9999 (within set value limit)		*	Sv-4
0424 _H	41061	Word	Ramp/soak No. 5 target value			*	Sv-5
0425 _H	41062	Word	Ramp/soak No. 6 target value			*	Sv-6
0426 _H	41063	Word	Ramp/soak No. 7 target value			*	Sv-7
0427 _H	41064	Word	Ramp/soak No. 8 target value			*	Sv-8
0428 _H	41065	Word	Ramp/soak No. 1 ramp time				TM1r
0429 _H	41066	Word	Ramp/soak No. 1 soak time				TM1S
042A _H	41067	Word	Ramp/soak No. 2 ramp time				TM2r
042B _H	41068	Word	Ramp/soak No. 2 soak time				TM2S
042C _H	41069	Word	Ramp/soak No. 3 ramp time	0 to 5999 (0 to 5999 min)			TM3r
042D _H	41070	Word	Ramp/soak No. 3 soak time	* With main unit parameter, Hour Minute is displayed and set.			TM3S
042E _H	41071	Word	Ramp/soak No. 4 ramp time	Therefore, correspondence occurs as: 3601:Data via communication 6001:Display/setting on main unit			TM4r
042F _H	41072	Word	Ramp/soak No. 4 soak time				TM4S
0430 _H	41073	Word	Ramp/soak No. 5 ramp time				TM5r
0431 _H	41074	Word	Ramp/soak No. 5 soak time				TM5S
0432 _H	41075	Word	Ramp/soak No. 6 ramp time				TM6r
0433 _H	41076	Word	Ramp/soak No. 6 soak time				TM6S
0434 _H	41077	Word	Ramp/soak No. 7 ramp time				TM7r
0435 _H	41078	Word	Ramp/soak No. 7 soak time				TM7S
0436 _H	41079	Word	Ramp/soak No. 8 ramp time				TM8r
0437 _H	41080	Word	Ramp/soak No. 8 soak time				TM8S
0438 _H	41081	Word	Ramp/soak mode	0 to 15			MOD
0439 _H	41082	Word	Ramp/soak command	0: oFF Ramp/soak stopped 1: rUn Ramp/soak operated 2: HLd Ramp/soak halted 3: End Ramp/soak ended	0: oFF Stop ramp/soak 1: rUn Start ramp/soak 2: HLd Halt ramp/soak		ProG

Note

Relative address	Resister No.	Type	Memory contents	Read-out data	Write-in data setting range	Affected by input range	Remarks or corresponding parameter
043A _H	41083	Word	Ramp/soak pattern selection	0: Execute No. 1 to 4 ramp/soak 1: Execute No. 5 to 8 ramp/soak 2: Execute No. 1 to 8 ramp/soak			PTn
043B _H	41084		(Do not use)				
043C _H	41085	Word	PV stable range	-1999 to 9999 (Within input scale)		*	SLFb
043D _H	41086		(Do not use)				
043E _H	41087	Word	Communication DI action request	*② (refer to section 7.4.)			
043F _H	41088	Word	Control action type code	0 to 19			P-n1
0440 _H	41089	Word	Output proportional cycle (output 1)	0: Current output type 1 to 150 (1 to 150 sec) : Relay, SSR drive output type			TC
0441 _H	41090	Word	Output proportional cycle (output 2)	1 to 150 (1 to 150 sec)			TC2
0442 _H	41091		(Do not use)				
0443 _H	41092	Word	Alarm 1 option function	0 to 7 (binary data 000 _B to 111 _B)			A1op
0444 _H	41093	Word	Alarm 2 option function	0 to 7 (binary data 000 _B to 111 _B)			A2op
0445 _H	41094		(Do not use)				
0446 _H	41095	Word	DI1 action setting	0 to 12			di-1
0447 _H	41096		(Do not use)				
0448 _H	41097	Word	Hysteresis mode setting	0: off (main unit parameter setting) 1: on (main unit parameter setting)			ONOF
0449 _H	41098	Word	(Do not use)				
044A _H	41099	Word	User zero adjustment	-1999 to 9999 (-50 to 50% value of input scale)		*	ADJ0
044B _H	41100	Word	User span adjustment	-1999 to 9999 (-50 to 50% value of input scale)		*	ADJS
044C _H	41101	Word	DSP1 (parameter mask designation)	0 to 255			dSP1
044D _H	41102	Word	DSP2 (parameter mask designation)	0 to 255			dSP2
044E _H	41103	Word	DSP3 (parameter mask designation)	0 to 255			dSP3
044F _H	41104	Word	DSP4 (parameter mask designation)	0 to 255			dSP4
0450 _H	41105	Word	DSP5 (parameter mask designation)	0 to 255			dSP5
0451 _H	41106	Word	DSP6 (parameter mask designation)	0 to 255			dSP6
0452 _H	41107	Word	DSP7 (parameter mask designation)	0 to 255			dSP7
0453 _H	41108	Word	DSP8 (parameter mask designation)	0 to 255			dSP8
0454 _H	41109	Word	DSP9 (parameter mask designation)	0 to 255			dSP9
0455 _H	41110	Word	DSP10 (parameter mask designation)	0 to 255			dSP10
0456 _H	41111	Word	DSP11 (parameter mask designation)	0 to 255			dSP11
0457 _H	41112	Word	DSP12 (parameter mask designation)	0 to 255			dSP12
0458 _H	41113	Word	DSP13 (parameter mask designation)	0 to 255			dSP13

Note) Read-out/write-in data from Resister No. 41083 (ramp/soak pattern selection) correspond to parameter “PTn” to be displayed as shown below:

Read-out/write-in data	Parameter PTn	Contents
0	1	1 to 4 ramp/soak executed
1	2	5 to 8 ramp/soak executed
2	3	1 to 8 ramp/soak executed

Word data (read-out only) : Function code [04_H]

Relative address	Resister No.	Type	Memory contents	Read-out data	Affected by input range	Remarks or corresponding parameter
03E8 _H	31001	Word	Process value (PV)	-1999 to 9999 (within input scale)	*	(Displayed PV value)
03E9 _H	31002	Word	Currently used set value (SV)	-1999 to 9999 (within set value limit)	*	(Dsiplayed SV value)
03EA _H	31003	Word	Currently used deviation (DV)	-1999 to 9999 (-100 to 100% value of input scale)	*	
03EB _H	31004	Word	MV (output 1)	-300 to 10300 (-3.00 to 103.00%)		OUT1
03EC _H	31005	Word	MV (output 2)	-300 to 10300 (-3.00 to 103.00%)		OUT2
03ED _H	31006	Word	Station No.	0 to 255		STno
03EE _H	31007	Word	Alarm status	*③ (refer to Section 7.4.)		
03EF _H	31008	Word	Input/main unit abnormal status	*④ (refer to Section 7.4.)		
03F0 _H	31009	Word	Ramp/soak current running position	0 to 17 *⑥ (refer to Section 7.4.)		STAT
03F1 _H	31010	Word	Heater current	0 to 500 (0.0 to 50.0A)		CT
03F2 _H	31011	Word	Timer 1 current count	0 to 9999 (0 to 9999 sec)		TM-1
03F3 _H	31012	Word	Timer 2 current count	0 to 9999 (0 to 9999 sec)		TM-2
03F4 _H	31013		(Reserve)			
03F5 _H	31014		(Reserve)			
03F6 _H	31015	Word	DI action status	*⑤ (refer to Section 7.4.)		

Notes)

- For details of * ② to * ⑥ in the table, refer to Section 7.4.
- The area marked (Do not use) is a reserve area. Do not write in there.
- Register numbers 31002 (currently used SV) and 41003 (face panel set SV) do not become the same value while switching-SV is active or ramp/soak is under way. (Example: While SV-1 is selected, the value of SV-1 is read out of register number 31002.) For reading out SV for monitoring, use SV in register number 31002.

7.4 Additional Explanation of Address Map

*② Register number 40087, 41087 (read-out/write-in area)

Contents of the communication DI action

Used for requesting a DI action via communication. Once written in, the contents remain held unless the power is turned off or another value is written in. Pay attention to this point particularly when canceling the alarm latching.

Read-out data is the data which was written in via communication and is different from hardware DI action request data (see * ⑤). Do not doubly request the action of the same function as hardware DI.

Bit	Contents	Read-out		Write-in	
		Bit	1 0	Bit	1 0
0	Switching-SV selection				
1		0 0	While selecting face panel set SV	0 0	While selecting face panel set SV
		0 1	While selecting SV-1	0 1	While selecting SV-1
2	(Reserve)				
3	(Reserve)				
4	(Reserve)				
5	Canceling the alarm 1 latching	0:Not requested to cancel the latching 1:Requested to cancel the latching		0:Not request to cancel the latching 1:Request to cancel the latching	
6	Canceling the alarm 2 latching	0:Not requested to cancel the latching 1:Requested to cancel the latching		0:Not request to cancel the latching 1:Request to cancel the latching	
7	(Reserve)				
8	ALM1 relay timer action	0:Timer action not requested 1:Timer action requested		0:Request to reset timer 1:Request to start timer	
9	ALM2 relay timer action	0:Timer action not requested 1:Timer action requested		0:Request to reset timer 1:Request to start timer	
10	(Reserve)				
11	(Reserve)				
12	(Reserve)				
13	(Reserve)				
14	(Reserve)				
15	(Reserve)				

*③ Register numbers 30007, 31007 (read-out only area)

Alarm status contents (bit data, Coil numbers 10009 to 10016 grouped in 1 byte.)

Bit	Contents	Read-out
0	Alarm 1 output (calculation result of de-energizing alarm)	0:Alarm 1 relay output OFF 1:Alarm 1 relay output ON
1	Alarm 2 output (calculation result of de-energizing alarm)	0:Alarm 2 relay output OFF 1:Alarm 2 relay output ON
2	(Reserve)	
3	HB alarm relay output	0:HB alarm output OFF 1:HB alarm output ON
4	Alarm 1 ON/OFF	0:Alarm 1 OFF, 1:Alarm 1 ON
5	Alarm 2 ON/OFF	0:Alarm 2 OFF, 1:Alarm 2 ON
6	(Reserve)	
7	HB alarm relay output	0:HB alarm output OFF 1:HB alarm output ON

*④ Register numbers 30008, 31008 (read-out only area)

Input/main unit abnormal status

Bit	Contents	Read-out
0	Input Lower open-circuit	0:Lower open-circuit absent 1:Lower open -circuit present
1	Input Upper open-circuit	0:Upper open-circuit absent 1:Upper open-circuit present
2	Input under-range	0:Under-range absent 1:Under-range present
3	Input over-range	0:Over-range absent 1:Over-range present
4	(Reserve)	
5	(Reserve)	
6	Setting range error	0:Setting range normal 1:Setting range abnormal
7	EEPROM error	0:EEPROM normal 1:EEPROM abnormal

*⑤ Register numbers 30015, 31015 (read-out only area)

Contents of DI action status

Hardware DI (DI input terminal) action request information

Bit	Contents	Read-out	
0 1	Switching-SV selection	Bit	1 0
			0 0
			0 1
	Face panel set SV selected		
	SV-1 selected		
2	Control RUN/standby	0:Control RUN requested 1:Control standby requested	
3	Auto tuning (standard)	0:AT not requested 1:AT (standard) action requested	
4	Auto tuning (low PV type)	0:AT not requested 1:AT (low PV type) action requested	
5	Canceling the alarm 1 latching	0:Not requested to cancel the latching 1:Requested to cancel the latching	
6	Canceling the alarm 2 latching	0:Not requested to cancel the latching 1:Requested to cancel the latching	
7	(Reserve)		
8	ALM1 relay timer action	0:Timer action not requested (timer reset) 1:Timer action requested	
9	ALM2 relay timer action	0:Timer action not requested (timer reset) 1:Timer action requested	
10	(Reserve)		
11	RUN/RESET selection of ramp/soak	0:Not requested RUN (RESET) 1:Requested RUN	
12	(Reserve)		
13	(Reserve)		
14	(Reserve)		
15	(Reserve)		

*⑥ Register numbers 30009, 31009 (read-out only area)

Ramp/soak current running position

Read-out data	Indication of parameter "STAT"	Running position (status)
0	oFF	Stop status of ramp/soak
1	1-rP	No. 1 ramp time
2	1-Sk	No. 1 soak time
3	2-rP	No. 2 ramp time
4	2-Sk	No. 2 soak time
5	3-rP	No. 3 ramp time
6	3-Sk	No. 3 soak time
7	4-rP	No. 4 ramp time
8	4-Sk	No. 4 soak time
9	5-rP	No. 5 ramp time
10	5-Sk	No. 5 soak time
11	6-rP	No. 6 ramp time
12	6-Sk	No. 6 soak time
13	7-rP	No. 7 ramp time
14	7-Sk	No. 7 soak time
15	8-rP	No. 8 ramp time
16	8-Sk	No. 8 soak time
17	End	End status of ramp/soak

8. SAMPLE PROGRAM

This section concerns data read-out/write-in sample program by GW-BASIC*¹ which operated on Windows 95*¹ MS-DOS*¹ PROMPT.

Note that the program shown here is for reference for you to create a program and not for guaranteeing all actions. Before executing the program, make sure of the communication conditions in the following procedure.

- Communication speed (baud rate), data length, stop bits and parity bit
Set in this program. Match the conditions with this instrument.

Note) Cautions on using SEKISUI's RS232C and RS485 converter unit (SI-30A)
In SI-30A, send data are received, added to start of the answer data from the slave station. After cleared data corresponding to the number of sending bytes, treat the remaining data as the answer data in the data receiving process.

*1: GW-BASIC, Windows 95 and MS-DOS are registered trademarks of Microsoft Corporation.

(a) Example of data read-out

Operation: Read-out PV, SV (currently used), DV and MV (control output 1) at a time.

(Continuous word read-out from read-out only area)

Used function code : 04H

Read-out start register No. : 31001 (Engineering unit data)

Read-out word number : 4

```
1000 '-----
1010 '   WRITE CONTINUOUS WORDS   SAMPLE PROGRAM
1020 '-----
1030 '
1040 '
1050 '
1060 CLS
1070 DIM CC(255)
1080 '
1100 '----- Send data setting -----
1110 CC(1)=&H01      'Station No. = 1
1120 CC(2)=&H06      'Function code = 06H
1130 CC(3)=&H04      'Upper byte of relative address(0439H) of resister No.41082
1140 CC(4)=&H39      'Lower byte of relative address(0439H) of resister No.41082
1150 CC(5)=&H00      'Upper byte of write-in word data(0001H)
1160 CC(6)=&H01      'Lower byte of write-in word data(0001H)
1170 COUNT=6
1200 '
1210 '----- CRC code calculation of send data -----
1220 GOSUB 3020      'GOSUB CRC.CALC
1230 CC(7)=CRC.L    'Lower byte of CRC calculation result -> Upper byte in message
1240 CC(8)=CRC.H    'Upper byte of CRC calculation result -> Lower byte in message
1250 COUNT=COUNT+2
1300 '
1310 '----- Send data -----
1320 PRINT "Sending data > ";
1330 OPEN "COM1:9600,o,8,1" AS #1 '9600bps, Odd Parity, Data Length=8, Stop bit=1
1340 FOR I=1 TO COUNT
1350   PRINT #1,CHR$(CC(I));      'Writing in transmission port
1360   PRINT RIGHT$("0"+HEX$(CC(I)),2);" "; 'Displaying on screen
1370 NEXT I
1380 '
1390 FOR I=0 TO 30000 :NEXT I      'Interval time
1500 '
1510 '----- Data receive -----
1520 PRINT
1530 LENGTH=LOC(1)      'Number of data in receiving buffer
1540 IF LENGTH=0 THEN PRINT "No answer" :END
1550 PRINT "Receiving data < ";
1560 FOR I=1 TO LENGTH
1570   X$=INPUT$(1,#1)      'Taking data from receiving buffer
1580   CC(I)=ASC(X$)      'Digitizing and storing
1590   PRINT RIGHT$("0"+HEX$(CC(I)),2);" "; 'Displaying on screen
1600 NEXT I
1610 CLOSE #1
1620 COUNT=LENGTH-2
1630 GOSUB 3020      'GOSUB CRC.CALC
1700 '
1710 '----- Transmission error check -----
1720 PRINT
```



```

1730 CRC.L$=RIGHT$("0"+HEX$(CRC.L),2)
1740 CRC.H$=RIGHT$("0"+HEX$(CRC.H),2)
1750 PRINT "CRC calculation = ";CRC.L$;" ";CRC.H$
1760 IF CC(LENGTH-1)<>CRC.L THEN GOTO 1790 'GOTO ER.MESSAGE
1770 IF CC(LENGTH)<>CRC.H THEN GOTO 1790 'GOTO ER.MESSAGE
1780 GOTO 1920 'GOTO PRT.RESULT
1790 'ER.MESSAGE
1800 PRINT "Communication error"
1810 END
1900 '
1910 '----- Display of result -----
1920 'PRT.RESULT
1930 PRINT
1940 PRINT "Completion of ramp/soak start-up"
1950 END
3000 '
3010 '----- CRC calculation -----
3020 'CRC.CALC 'For contents, refer to CRC calculation flow chart
3030 CR=&HFFFF
3040 FOR I=1 TO COUNT
3050 CR=CR XOR CC(I)
3060 FOR J=1 TO 8
3070 CT=CR AND &H1
3080 IF CR<0 THEN CH=1 ELSE CH=0:GOTO 3100 'GOTO CRC.CALC.10
3090 CR=CR AND &H7FFF
3100 'CRC.CALC.10
3110 CR=INT(CR/2)
3120 IF CH=1 THEN CR=CR OR &H4000
3130 IF CT=1 THEN CR=CR XOR &HA001
3140 NEXT J
3150 NEXT I
3160 CRC.L=CR AND &HFF 'Lower byte of CRC calculation
3170 CRC.H=((CR AND &HFF00)/256 AND &HFF) 'Upper byte of CRC calculation
3180 RETURN

```

(b) Data write-in example

Operation : Start ramp/soak of No. 1 station via communication
(Single word write-in)

Used function code : 06H

Write-in register No. : 41082 (Table of engineering unit data)

Write-in data : 1 (Ramp/soak start)

```
1000 '-----
1010 ' READ CONTINUOUS WORDS SAMPLE PROGRAM
1020 '-----
1030 '
1040 '
1050 '
1060 CLS
1070 DIM CC(255)
1080 '
1100 '----- Send data setting -----
1110 CC(1)=&H01 'Station No. = 1
1120 CC(2)=&H04 'Function code = 04H
1130 CC(3)=&H03 'Upper byte of relative address(03E8H) of register No.31001
1140 CC(4)=&HE8 'Lower byte of relative address(03E8H) of register No.31001
1150 CC(5)=&H00 'Upper byte of read-out word number(0004H)
1160 CC(6)=&H04 'Lower byte of read-out word number(0004H)
1170 COUNT=6
1200 '
1210 '----- CRC code calculation of send data -----
1220 GOSUB 3020 'GOSUB CRC.CALC
1230 CC(7)=CRC.L 'Lower byte of CRC calculation result -> Upper byte in message
1240 CC(8)=CRC.H 'Upper byte of CRC calculation result -> Lower byte in message
1250 COUNT=COUNT+2
1300 '
1310 '----- Send data -----
1320 PRINT "Sending data > ";
1330 OPEN "COM1:9600,o,8,1" AS #1 '9600bps, Odd Parity, Data Length=8, Stop bit=1
1340 FOR I=1 TO COUNT
1350 PRINT #1,CHR$(CC(I)); 'Writing in transmission port
1360 PRINT RIGHT$("0"+HEX$(CC(I)),2);" "; 'Displaying on screen
1370 NEXT I
1380 '
1390 FOR I=0 TO 30000 :NEXT I 'Interval time
1500 '
1510 '----- Data receive -----
1520 PRINT
1530 LENGTH=LOC(1) 'Number of data in receiving buffer
1540 IF LENGTH=0 THEN PRINT "No answer" :END
1550 PRINT "Receiving data < ";
1560 FOR I=1 TO LENGTH
1570 X$=INPUT$(1,#1) 'Taking data from receiving buffer
1580 CC(I)=ASC(X$) 'Digitizing and storing
1590 PRINT RIGHT$("0"+HEX$(CC(I)),2);" "; 'Displaying on screen
1600 NEXT I
1610 CLOSE #1
1620 COUNT=LENGTH-2
1630 GOSUB 3020 'GOSUB CRC.CALC
1700 '
1710 '----- Transmission error check -----
1720 PRINT
```

```

1730 CRC.L$=RIGHT$("0"+HEX$(CRC.L),2)
1740 CRC.H$=RIGHT$("0"+HEX$(CRC.H),2)
1750 PRINT "CRC calculation = ";CRC.L$;" ";CRC.H$
1760 IF CC(LENGTH-1)<>CRC.L THEN GOTO 1790 'GOTO ER.MESSAGE
1770 IF CC(LENGTH)<>CRC.H THEN GOTO 1790 'GOTO ER.MESSAGE
1780 GOTO 1920 'GOTO PRT.RESULT
1790 'ER.MESSAGE
1800 PRINT "Communication error"
1810 END
1900 '
1910 '----- Display of result -----
1920 'PRT.RESULT
1930 ' In case of decimal point position(P-dP)=1
1940 PRINT
1950 PV$=HEX$(CC(4))+RIGHT$("0"+HEX$(CC(5)),2) '2 bytes -> 1 word
1960 SV$=HEX$(CC(6))+RIGHT$("0"+HEX$(CC(7)),2) '2 bytes -> 1 word
1970 DV$=HEX$(CC(8))+RIGHT$("0"+HEX$(CC(9)),2) '2 bytes -> 1 word
1980 MV$=HEX$(CC(10))+RIGHT$("0"+HEX$(CC(11)),2) '2 bytes -> 1 word
1990 PRINT "PV =" ;VAL("&H"+PV$)/10;"degree C" '1 place of decimal
2000 PRINT "SV =" ;VAL("&H"+SV$)/10;"degree C" '1 place of decimal
2010 PRINT "DV =" ;VAL("&H"+DV$)/10;"degree C" '1 place of decimal
2020 PRINT "MV1=" ;VAL("&H"+MV$)/100;"%" 'MV is data of 2 places of decimal
2030 END
3000 '
3010 '----- CRC calculation -----
3020 'CRC.CALC 'For contents, refer to CRC calculation flow chart
3030 CR=&HFFFF
3040 FOR I=1 TO COUNT
3050 CR=CR XOR CC(I)
3060 FOR J=1 TO 8
3070 CT=CR AND &H1
3080 IF CR<0 THEN CH=1 ELSE CH=0:GOTO 3100 'GOTO CRC.CALC.10
3090 CR=CR AND &H7FFF
3100 'CRC.CALC.10
3110 CR=INT(CR/2)
3120 IF CH=1 THEN CR=CR OR &H4000
3130 IF CT=1 THEN CR=CR XOR &HA001
3140 NEXT J
3150 NEXT I
3160 CRC.L=CR AND &HFF 'Lower byte of CRC calculation
3170 CRC.H=((CR AND &HFF00)/256 AND &HFF) 'Upper byte of CRC calculation
3180 RETURN

```

9. TROUBLESHOOTING

If the communication is unavailable, check the following items.

- Whether all devices related to communication are turned on.
- Whether connections are correct.
- Whether the number of connected instruments and connection distance are as specified
- Whether communication conditions coincide between the master station (host computer) and slave stations (PXR)
 - Transmission speed : 9600bps
 - Data length : 8 bits
 - Stop bit : 1 bit
 - Parity : odd
even
none
- Whether send/receive signal timing conforms to Section 5.4 in this manual.
- Whether the station No. designated as send destination by the master station coincides with the station No. of the connected PXR
- Whether more than one instrument connected on the same transmission line shares the same station No.
- Whether the station No. of instruments is set at other than 0.
If it's 0, the communication function does not work.
- Whether the 11th digit of type cord of this controller is M or V?.

(PXR4□□□□ – □□ $\begin{matrix} M \\ V \end{matrix}$ □□ – □)